

Features of the Cross Roller Table

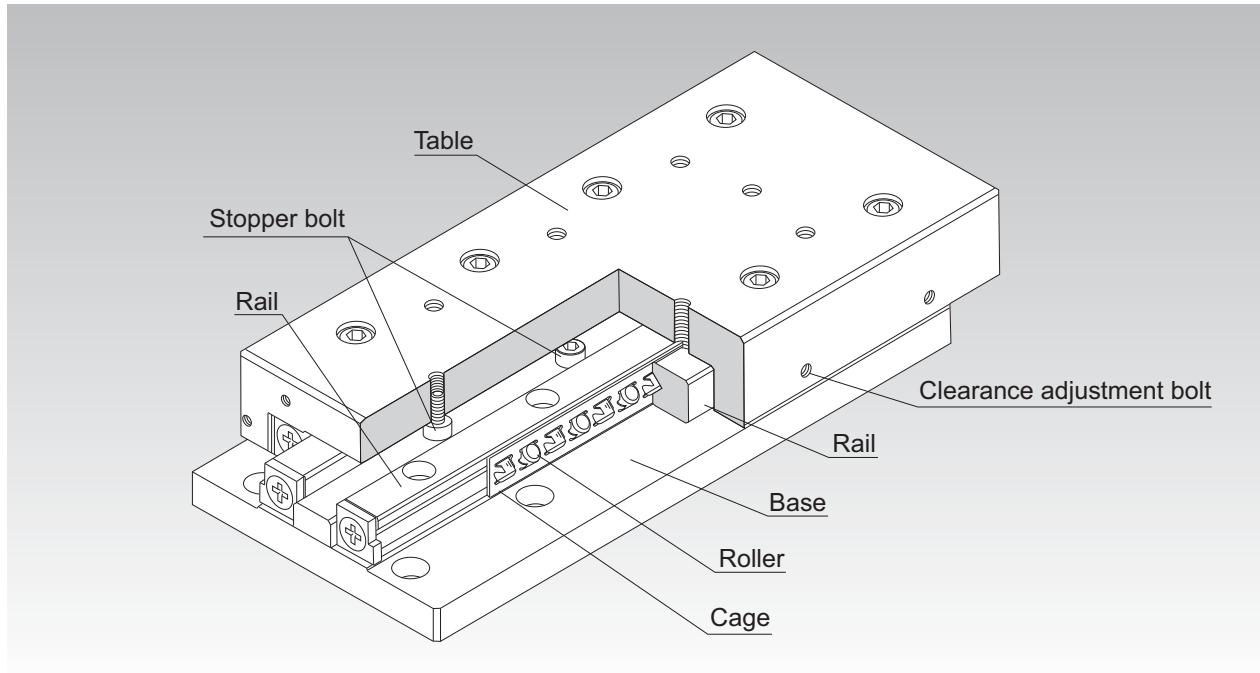

Fig.1 Structure of the Cross Roller Table

Structure and Features

The Cross Roller Table is a compact, highly rigid finite linear guide unit that has the Cross Roller Guide(s) between the precision-machined table and base.

There are two types of the Cross Roller Table: model VRU, and a miniature type model VRT. The Cross Roller Table is used in extensive applications such as OA equipment and peripherals, measuring instruments and printed circuit board drilling machines.

Features of the Cross Roller Table

[Easy Installation]

Since the Cross Roller Guide(s) is installed between the precision-machined table and base, a highly accurate linear guide mechanism is achieved simply by mounting the product with bolts.

[Large Permissible Load]

Since rollers with large rated loads are installed in short pitches, the cross roller guide is capable of bearing a heavy load, achieving a highly rigid linear guide mechanism and gaining a long service life.

[Diversified Usage]

Since the rollers are orthogonally arranged one after another, the guide system is capable of evenly receiving loads in the four directions applied on the table. (See Fig.2.)

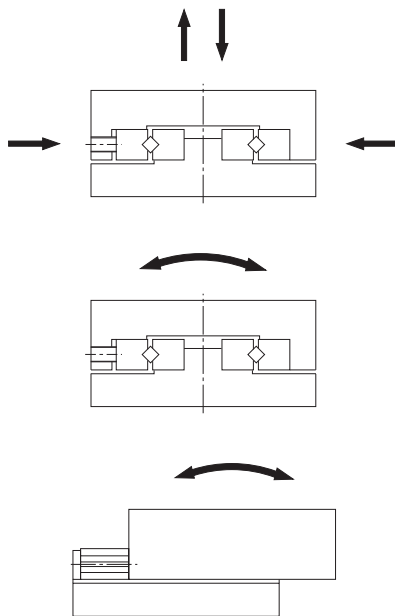
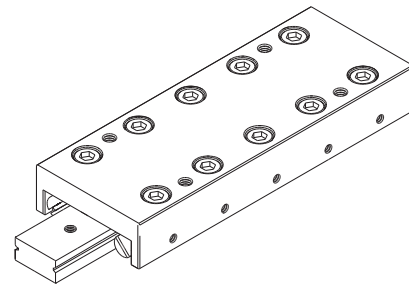

Fig.2 Load Directions

[Highly Corrosion Resistant]

The base and the table of models VRT-M and VRT-AM use stainless steel. Their rails, rollers, roller cages and screws are also made of stainless steel. As a result, these guide systems have significantly high corrosion resistance.

The base and the table of model VRU-M are made of aluminum.



Model VRT

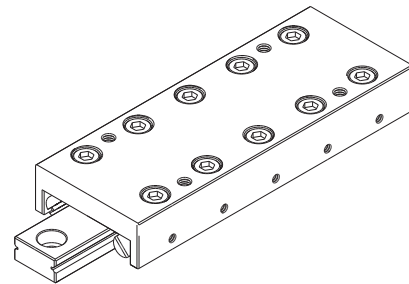

Model VRT-A

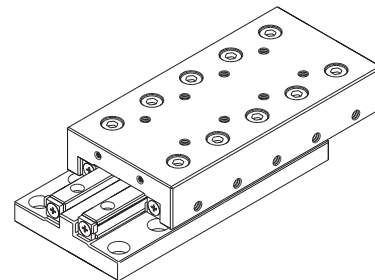

Model VRU

Rated Load and Nominal Life

[Rated Loads in All Directions]

The rated loads of models VRT, VRT-A and VRU are equal in four directions (radial, reverse radial and lateral directions), and their values are expressed as C and C₀ in the corresponding specification tables.

[Static Safety Factor f_s]

The Cross Roller Table may receive an unexpected external force while it is stationary or operative due to the generation of an inertia caused by vibrations and impact or start and stop. It is necessary to consider a static safety factor against such a working load.

$$f_s = \frac{C_0}{P_c} \quad \text{or} \quad f_s = \frac{M_0}{M}$$

- f_s : Static safety factor
- C₀ : Basic static load rating (kN)
- M₀ : Static permissible moment (M_A, M_B and M_C)
- P_c : Calculated load (kN)
- M : Calculated moment (kN)

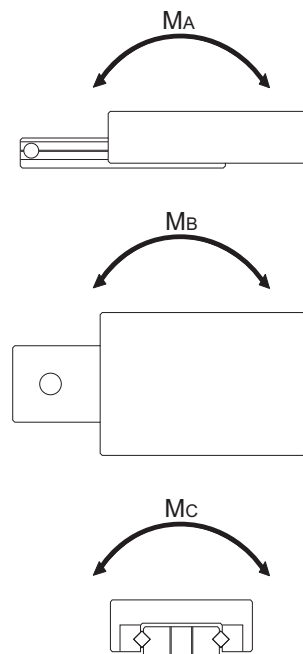

● Reference value of static safety factor

The static safety factors indicated in Table1 are the lower limits of reference values in the respective conditions.

Table1 Reference Values of Static Safety Factor (f_s)

Machine using the LM system	Basic dynamic load rating	Lower limit of f _s
General industrial machinery	Without vibration or impact	1 to 1.3
	With vibration or impact	2 to 3

[Nominal Life]

The nominal life of the Cross Roller Table is obtained using the following equation.

$$L = \left(\frac{f_T}{f_w} \cdot \frac{C}{P_c} \right)^{\frac{10}{3}} \times 100$$

- L : Nominal life (km)
 (The total number of revolutions that 90% of a group of identical VRT, VRT-A or VRU units independently operating under the same conditions can achieve without showing flaking)
- C : Basic dynamic load rating (kN)
- P_c : Calculated radial load (kN)
- f_T : Temperature factor
 (see Fig.1 on **A8-6**)
- f_w : Load factor (see Table2 on **A8-6**)

[Calculating the Service Life Time]

When the nominal life (L) has been obtained, if the stroke length and the number of reciprocations per minute are constant, the service life time is obtained using the following equation.

$$L_h = \frac{L \times 10^6}{2 \times l_s \times n_1 \times 60}$$

- L_h : Service life time (h)
- l_s : Stroke length (mm)
- n₁ : Number of reciprocations per minute (min⁻¹)

● **f_T: Temperature Factor**

If the temperature of the environment surrounding the operating model VRT, VRT-A or VRU exceeds 100°C, take into account the adverse effect of the high temperature and multiply the basic load ratings by the temperature factor indicated in Fig.1.

Note) If the environment temperature exceeds 100°C, contact THK.

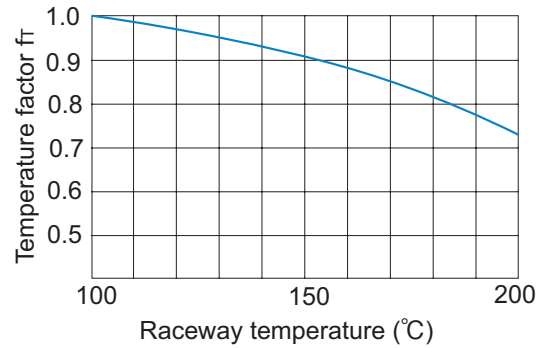

Fig.1 Temperature Factor (f_T)

● **f_w: Load Factor**

In general, reciprocating machines tend to involve vibrations or impact during operation. It is extremely difficult to accurately determine vibrations generated during high-speed operation and impact during frequent start and stop. Therefore, when the actual load applied on model VRT, VRT-A or VRU cannot be obtained, or when speed and vibrations have a significant influence, divide the basic load rating (C or C₀), by the corresponding load factor in Table2 of empirically obtained data.

Table2 Load Factor (f_w)

Vibrations/impact	Speed (V)	f _w
Faint	Very low V ≤ 0.25m/s	1 to 1.2
Weak	Slow 0.25 < V ≤ 1m/s	1.2 to 1.5

Accuracy Standards

The dimensional tolerances of Cross Roller Table models VRT, VRT-A and VRU in height (M) and width (W), and the running accuracy of the base against the mounting surfaces C and D are indicated in the corresponding specification tables.

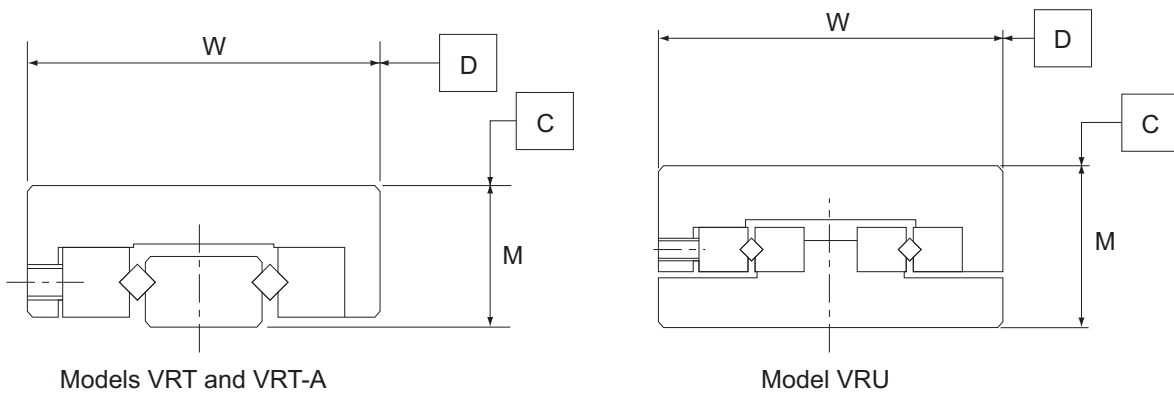
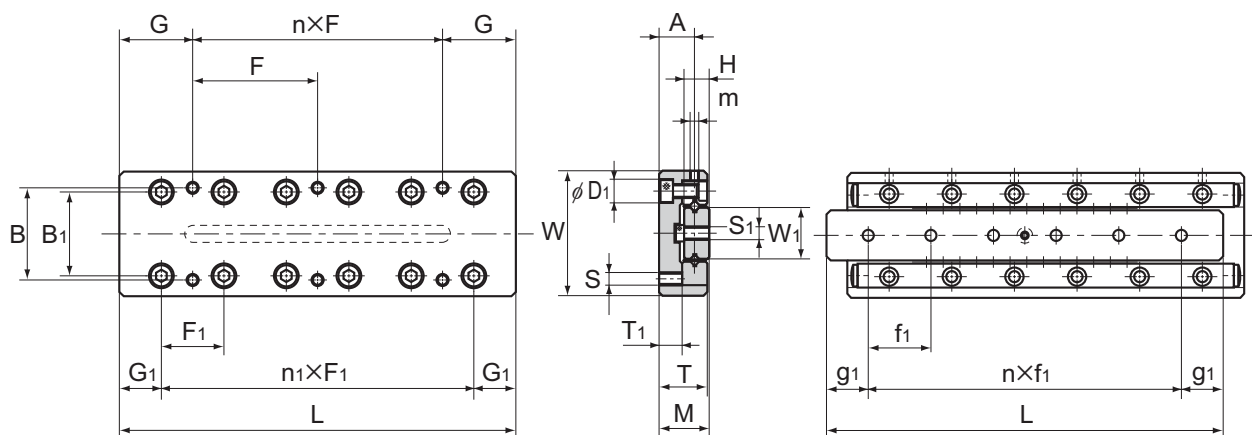

Fig.2 Accuracy Standards



Cross Roller Table

Model VRT Miniature Type (Tapped Base Type)



Model No.	Main dimensions					Table surface dimensions							
	Maximum stroke	Width W ± 0.1	Height M ± 0.1	Length L	Mass g	Table mounting tap position				$n_1 \times F_1$	B_1	D_1	G_1
						B	$n \times F$	G	S				
VRT 1025	12	20	8	25	23	14	1 × 18	3.5	M2.6	1 × 10	12.4	4.1	7.5
VRT 1035	18			35	32		1 × 28	3.5		2 × 10			
VRT 1045	25			45	42		1 × 20	12.5		3 × 10			
VRT 1055	32			55	52		1 × 30	12.5		4 × 10			
VRT 1065	40			65	62		2 × 20	12.5		5 × 10			
VRT 1075	45			75	72		1 × 30	22.5		6 × 10			
VRT 1085	50			85	82		2 × 30	12.5		7 × 10			
VRT 2035	18	30	12	35	78	22	1 × 28	3.5	M3	1 × 15	20	6	10
VRT 2050	30			50	113		1 × 43	3.5		2 × 15			
VRT 2065	40			65	147		1 × 30	17.5		3 × 15			
VRT 2080	50			80	184		1 × 45	17.5		4 × 15			
VRT 2095	60			95	220		2 × 30	17.5		5 × 15			
VRT 2110	70			110	257		1 × 45	32.5		6 × 15			
VRT 2125	80			125	290		2 × 45	17.5		7 × 15			
VRT 3055	30	40	16	55	229	30	1 × 40	7.5	M4	1 × 25	28.4	7.5	15
VRT 3080	45			80	336		1 × 65	7.5		2 × 25			
VRT 3105	60			105	442		1 × 50	27.5		3 × 25			
VRT 3130	75			130	551		1 × 75	27.5		4 × 25			
VRT 3155	90			155	657		2 × 50	27.5		5 × 25			
VRT 3180	105			180	766		1 × 75	52.5		6 × 25			
VRT 3205	130			205	871		2 × 75	27.5		7 × 25			

Note) All stainless steel type with high corrosion resistance is also available.

(Example) VRT 2035 M

Symbol for stainless steel type

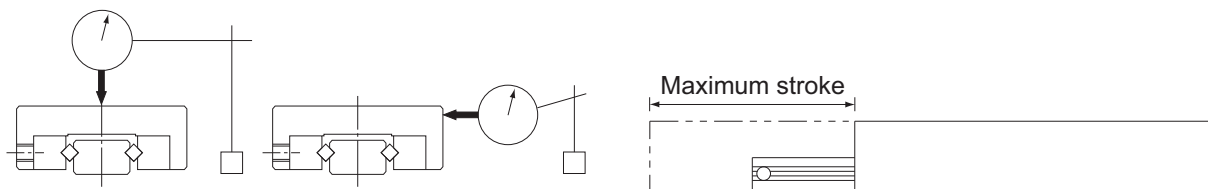
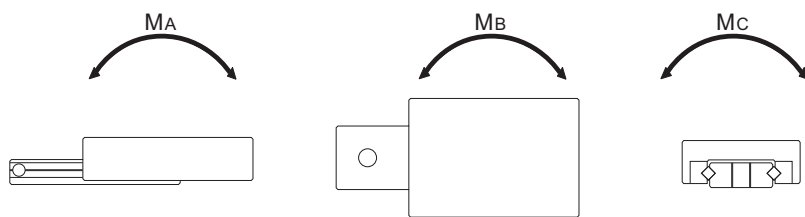

Accuracy: ΔC

Accuracy: ΔD

Unit: mm

Side surface dimensions							Base surface dimensions Mounting hole position				Basic load rating		Static permissible moment			Accuracy μm	
T	T ₁	H	W ₁	A	m	S ₁	n×f ₁	g ₁	No. of rollers Z	C kN	C ₀ kN	M _A N-m	M _B N-m	M _C N-m	ΔC	ΔD	
7.5	3.5	4	6.7	5.5	M2	M2.6	2×7.5	5	5	0.46	0.61	1.52	1.25	2.29	2	4	
							2×10		7	0.63	0.92	2.62	2.32	3.44			
							3×10		10	0.95	1.53	4.14	4.53	5.73			
							4×10		12	1.09	1.83	5.92	6.41	6.87			
							5×10		7.5	14	1.23	2.14	8.08	8.62			8.02
							6×10			18	1.50	2.75	13.3	14.0			10.3
							7×10			20	1.63	3.05	16.4	17.2			11.5
11.5	5.5	6	12.2	8.5		M3	1×20	10	5	0.84	1.09	4.32	3.55	7.06		5	
							2×15		7	1.16	1.63	7.45	6.59	10.6			
							3×15		9	1.46	2.17	11.8	10.5	14.1			
							4×15		12	2.01	3.26	16.8	18.2	21.2			
							5×15		14	2.26	3.80	23.0	24.5	24.7			
							6×15		17	2.51	4.34	37.9	35.7	28.2			
							7×15		19	2.76	4.89	46.7	44.3	31.8			
15.5	7.5	8	16	11.5	M4	1×35	15	6	2.71	3.67	12.2	13.9	31.9	3	6		
						2×25		10	4.06	6.11	33.1	36.2	53.1				
						3×25		13	4.68	7.33	64.6	59.8	63.8				
						4×25		17	5.87	9.77	107	100	85				
						5×25		20	6.98	12.2	131	138	106				
						6×25		24	8.05	14.7	189	196	128				
						7×25		26	8.57	15.9	222	230	138				

Cross Roller Table

Model VRT-A Miniature Type (Tapped Base Type)

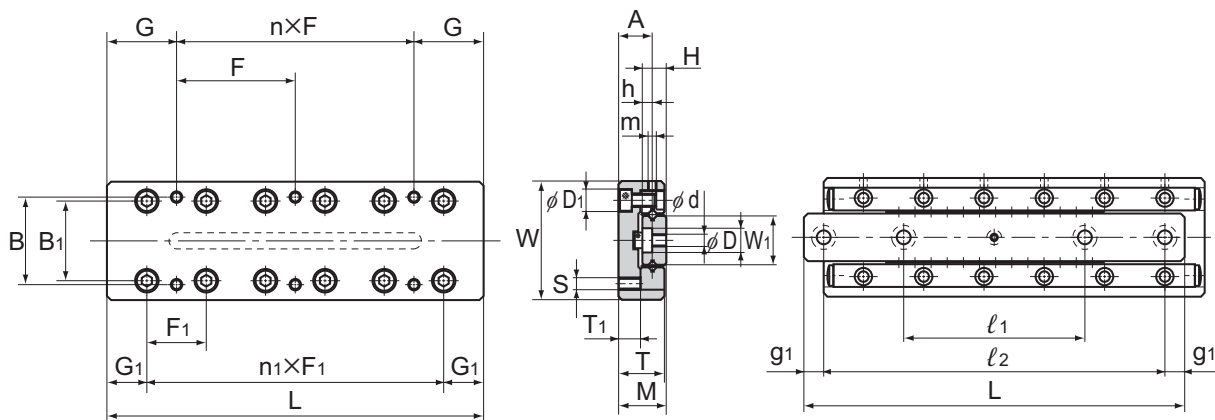

Model No.	Main dimensions					Table surface dimensions							
	Maximum stroke	Width W ± 0.1	Height M ± 0.1	Length L	Mass g	Table mounting tap position				$n_1 \times F_1$	B_1	D_1	G_1
						B	$n \times F$	G	S				
VRT 1025A	12	20	8	25	23	14	1 × 18	3.5	M2.6	1 × 10	12.4	4.1	7.5
VRT 1035A	18			35	32		1 × 28	3.5		2 × 10			
VRT 1045A	25			45	42		1 × 20	12.5		3 × 10			
VRT 1055A	32			55	52		1 × 30	12.5		4 × 10			
VRT 1065A	40			65	62		2 × 20	12.5		5 × 10			
VRT 1075A	45			75	72		1 × 30	22.5		6 × 10			
VRT 1085A	50			85	82		2 × 30	12.5		7 × 10			
VRT 2035A	18	30	12	35	78	22	1 × 28	3.5	M3	1 × 15	20	6	10
VRT 2050A	30			50	113		1 × 43	3.5		2 × 15			
VRT 2065A	40			65	147		1 × 30	17.5		3 × 15			
VRT 2080A	50			80	181		1 × 45	17.5		4 × 15			
VRT 2095A	60			95	217		2 × 30	17.5		5 × 15			
VRT 2110A	70			110	254		1 × 45	32.5		6 × 15			
VRT 2125A	80			125	287		2 × 45	17.5		7 × 15			
VRT 3055A	30	40	16	55	226	30	1 × 40	7.5	M4	1 × 25	28.4	7.5	15
VRT 3080A	45			80	333		1 × 65	7.5		2 × 25			
VRT 3105A	60			105	439		1 × 50	27.5		3 × 25			
VRT 3130A	75			130	548		1 × 75	27.5		4 × 25			
VRT 3155A	90			155	652		2 × 50	27.5		5 × 25			
VRT 3180A	105			180	761		1 × 75	52.5		6 × 25			
VRT 3205A	130			205	866		2 × 75	27.5		7 × 25			

Note) All stainless steel type with high corrosion resistance is also available.

(Example) VRT 2035A M

└─── Symbol for stainless steel type

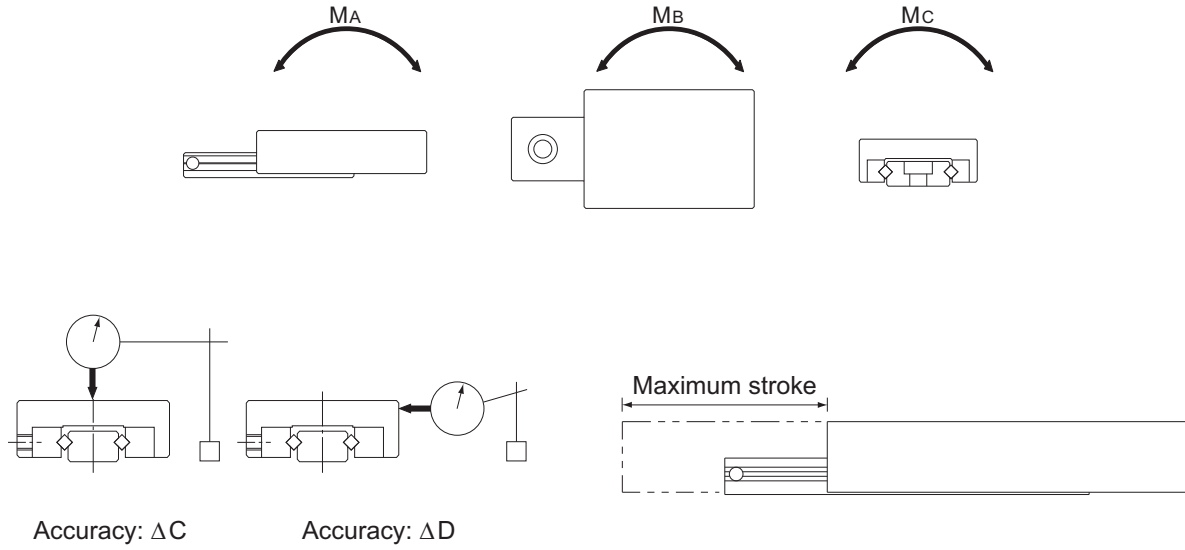

Unit: mm

Cross Roller Table

Side surface dimensions							Base surface dimensions Mounting hole position					Basic load rating		Static permissible moment			Accuracy μm	
T	T ₁	H	W ₁	A	m	d×D×h	l ₁	l ₂	g ₁	No. of rollers Z	C kN	C ₀ kN	M _A N-m	M _B N-m	M _C N-m	ΔC	ΔD	
7.5	3.5	4	6.7	5.5	M2	2.5×4.1×2.2	—	18	3.5	5	0.46	0.61	1.52	1.25	2.29	2	4	
							—	25	5	7	0.63	0.92	2.62	2.32	3.44			
							25	38	3.5	10	0.95	1.53	4.14	4.53	5.73			
							29	48	3.5	12	1.09	1.83	5.92	6.41	6.87			
							31	55	5	14	1.23	2.14	8.08	8.62	8.02			
							35	65	5	18	1.50	2.75	13.3	14.0	10.3			
							40	75	5	20	1.63	3.05	16.4	17.2	11.5			
11.5	5.5	6	12.2	8.5		3.5×6×3.2	—	25	5	5	0.84	1.09	4.32	3.55	7.06		5	4
							—	35	7.5	7	1.16	1.63	7.45	6.59	10.6			
							33	55	5	9	1.46	2.17	11.8	10.5	14.1			
							40	70	5	12	2.01	3.26	16.8	18.2	21.2			
							45	85	5	14	2.26	3.80	23.0	24.5	24.7			
							50	95	7.5	17	2.51	4.34	37.9	35.7	28.2			
							55	110	7.5	19	2.76	4.89	46.7	44.3	31.8			
15.5	7.5	8	16	11.5	4.5×7.5×4.2	—	40	7.5	6	2.71	3.67	12.2	13.9	31.9	3	6		
						43	68	6	10	4.06	6.11	33.1	36.2	53.1				
						55	90	7.5	13	4.68	7.33	64.6	59.8	63.8				
						65	115		17	5.87	9.77	107	100	85				
						95	140		20	6.98	12.2	131	138	106				
						85	165		24	8.05	14.7	189	196	128				
						90	190		26	8.57	15.9	222	230	138				

Model VRU

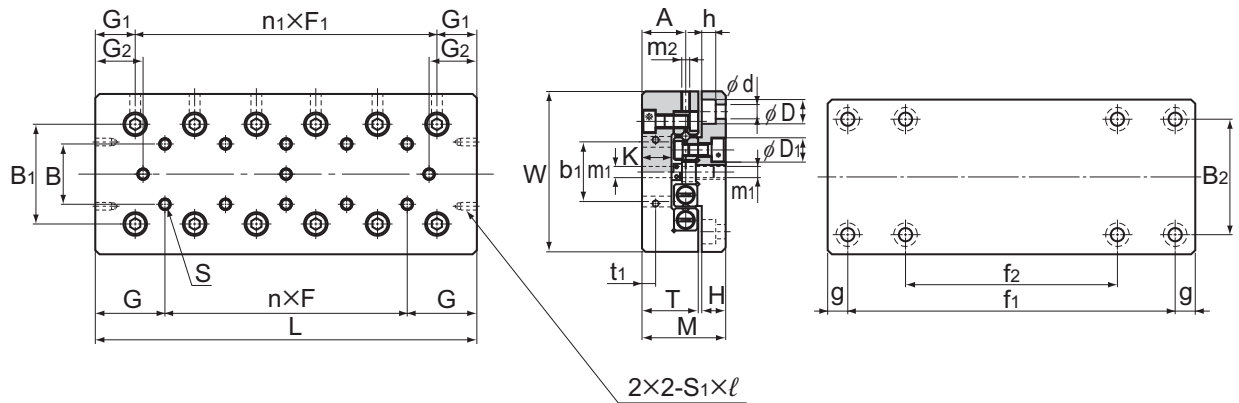

Model No.	Main dimensions					Table surface dimensions										
	Maximum stroke	Width W -0.2 -0.4	Height M ±0.1	Length L	Mass ^(Note) kg	Table mounting tap position				Side surface mounting tap position						
						B	n x F	G	S	B ₁	n ₁ x F ₁	G ₁	G ₂	b ₁	t ₁	S ₁ x l
VRU 1025	12	30	17	25	0.08(0.04)	10	—	12.5	M2	18.4	1 x 10	7.5	7.5	12	2.5	M2 x 4
VRU 1035	18			35	0.11(0.05)		1 x 10				4.5					
VRU 1045	25			45	0.15(0.07)		2 x 10				6					
VRU 1055	32			55	0.18(0.09)		3 x 10				7.5					
VRU 1065	40			65	0.21(0.1)		4 x 10				8.5					
VRU 1075	45			75	0.24(0.12)		5 x 10				11					
VRU 1085	50			85	0.27(0.13)		6 x 10				13.5					
VRU 2035	18	40	21	35	0.2(0.09)	15	—	17.5	M3	25	1 x 15	10	9.5	16	3.4	
VRU 2050	30			50	0.26(0.13)		1 x 15				4.5					
VRU 2065	40			65	0.34(0.17)		2 x 15				7					
VRU 2080	50			80	0.42(0.21)		3 x 15				9.5					
VRU 2095	60			95	0.5(0.25)		4 x 15				12					
VRU 2110	70			110	0.58(0.29)		5 x 15				14.5					
VRU 2125	80			125	0.66(0.33)		6 x 15				17					

Note) Stainless steel type with high corrosion resistance is also available.
The value in the parentheses represents the mass of a stainless steel type.

(Example) VRU 2035 M

Symbol for stainless steel type
(table base: aluminum)

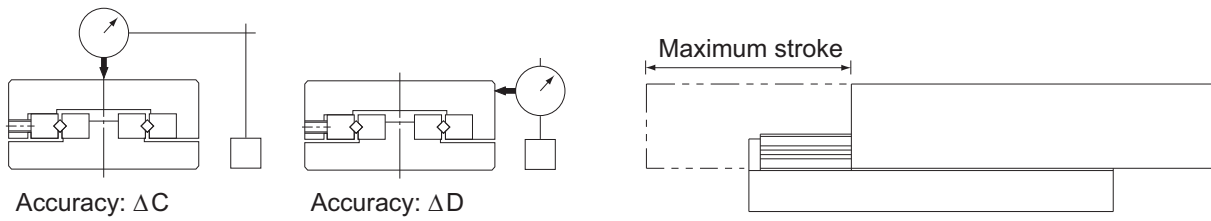
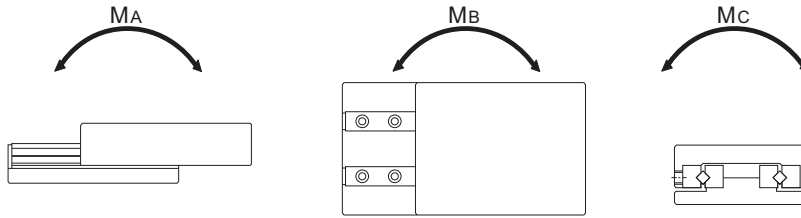

Unit: mm

Cross Roller Table

										Base surface dimensions Mounting hole position				Basic load rating		Static permissible moment			Accuracy μm		
										B ₂	f ₁	f ₂	g	No. of rollers Z	C kN	C ₀ kN	M _A N-m	M _B N-m	M _C N-m	ΔC	ΔD
T	H	K	d×D×h	D ₁	m ₁	A	m ₂														
11	5.5	6.5	2.55×4.1×2.5	4.1	M2	9	M2	22	18	—	3.5	5	0.46	0.61	1.52	1.25	4.12	2	4		
									28	—		7	0.63	0.92	2.62	2.32	6.18				
									38	—		10	0.95	1.53	4.14	4.53	10.3				
									48	28		12	1.09	1.83	5.92	6.41	12.4				
									58	38		14	1.23	2.14	8.08	8.62	14.4				
									68	48		18	1.50	2.75	13.3	14.0	18.6				
									78	58		20	1.63	3.05	16.4	17.2	20.6				
14	6.5	7.5	3.5×6×3.5	6	M3	11	M3	30	25	—	5	5	0.84	1.09	4.32	3.55	9.77	3	6		
									40	—		7	1.16	1.63	7.45	6.59	14.7				
									55	—		9	1.46	2.17	11.8	10.6	19.5				
									70	40		12	2.01	3.26	16.9	18.2	29.3				
									85	55		14	2.26	3.80	23	24.5	34.2				
									100	70		17	2.51	4.34	37.9	35.7	39.1				
									115	85		19	2.76	4.89	46.7	44.3	44.0				

Model VRU

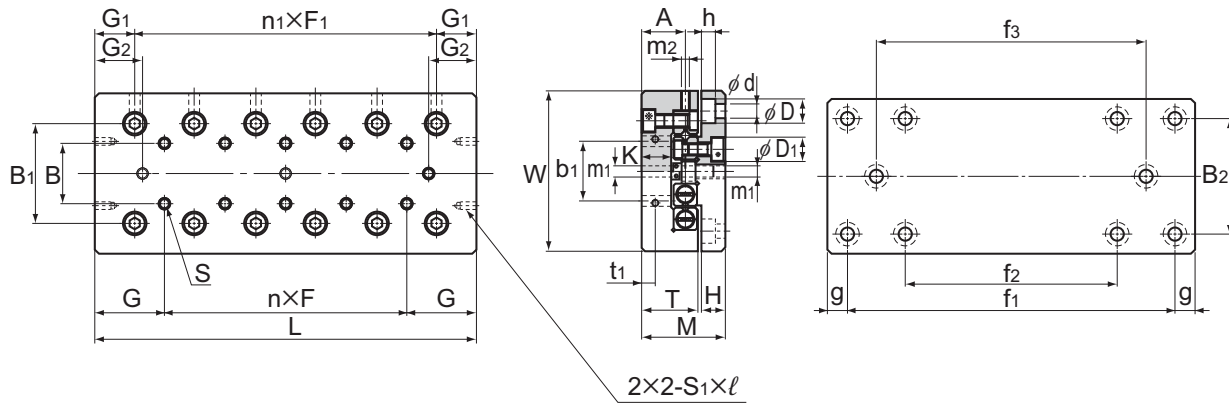

Model No.	Main dimensions					Table surface dimensions										
	Maximum stroke	Width W ± 0.1	Height M ± 0.1	Length L	Mass ^(Note) kg	Table mounting tap position				Side surface mounting tap position						
						B	$n \times F$	G	S	B_1	$n_1 \times F_1$	G_1	G_2	b_1	t_1	$S_1 \times \ell$
VRU 3055	30	60	28	55	0.57(0.3)	25	—	27.5	M4	39	1×25	15	5.5	40	5.5	M3×6
VRU 3080	45			80	0.8(0.4)		1×25				10.5					
VRU 3105	60			105	1.03(0.6)		2×25				15.5					
VRU 3130	75			130	1.26(0.7)		3×25				20.5					
VRU 3155	90			155	1.49(0.9)		4×25				25.5					
VRU 3180	105			180	1.72(1)		5×25				30.5					
VRU 3205	130			205	1.95(1.1)		6×25				30.5					
VRU 4085	50	80	35	85	1.5(0.8)	—	40	42.5	M5	53	1×40	22.5	10.5	55	6.5	
VRU 4125	75			125	2.3(1.2)	1×40					18					
VRU 4165	105			165	3.1(1.5)	2×40					23					
VRU 4205	135			205	3.8(1.9)	3×40					30.5					
VRU 4245	155			245	4.6(2.2)	4×40					38					
VRU 4285	185			285	5.3(2.6)	5×40					43					

Note) Stainless steel type with high corrosion resistance is also available.
The value in the parentheses represents the mass of a stainless steel type.

(Example) VRU 3080 M

Symbol for stainless steel type

(table base: aluminum)

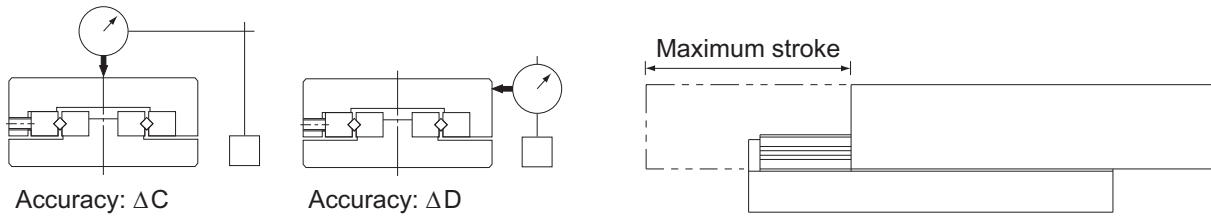
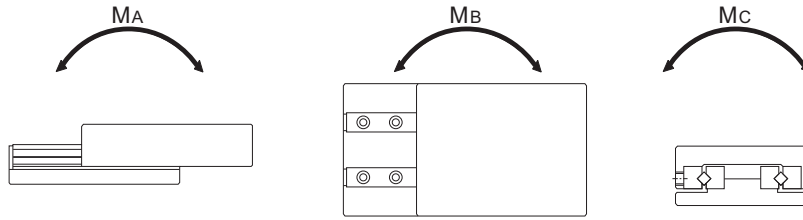

Unit: mm

Cross Roller Table

										Base surface dimensions Mounting hole position					Basic load rating		Static permissible moment			Accuracy μm										
T	H	K	d×D×h	D ₁	m ₁	A	m ₂	B ₂	f ₁	f ₂	f ₃	g	No. of rollers Z	C kN	C ₀ kN	M _A N-m	M _B N-m	M _C N-m	ΔC	ΔD										
18.5	9	10	4.5×7.5×5	7.5	M4	14.5	M4	40	35	—	—	10	6	2.71	3.67	12.2	13.9	51.3	2	5										
									60	—	—		10	4.06	6.11	33.1	36.2	85.5												
									85	—	—		13	4.68	7.33	64.6	59.8	103	3	6										
									110	—	—		17	5.87	9.77	107	100	137												
									135	—	85		20	6.98	12.2	131	138	171												
									24	10.5	12.5		5.5×9.5×6	9.5	M4	18.5	M4	60	160	—	110	22.5	24	8.05	14.7	189	196	205	2	5
																			185	85	135		26	8.57	15.9	222	230	222		
65	—	—	7	5.90	8.11	64.9	57.4	162				3							6											
80	—	—	11	8.82	13.5	147	134	270																						
120	—	—	14	11.5	18.9	200	214	378																						
7	7	7	7	7	7	7	7	7				160							80	—	18		14.0	24.3	330	347	486	3	7	
												200							120	—	22		16.3	29.7	492	513	594			
7	7	7	7	7	7	7	7	7	240	160	—	26	18.6	35.1	687	711	703	3	7											

Model VRU

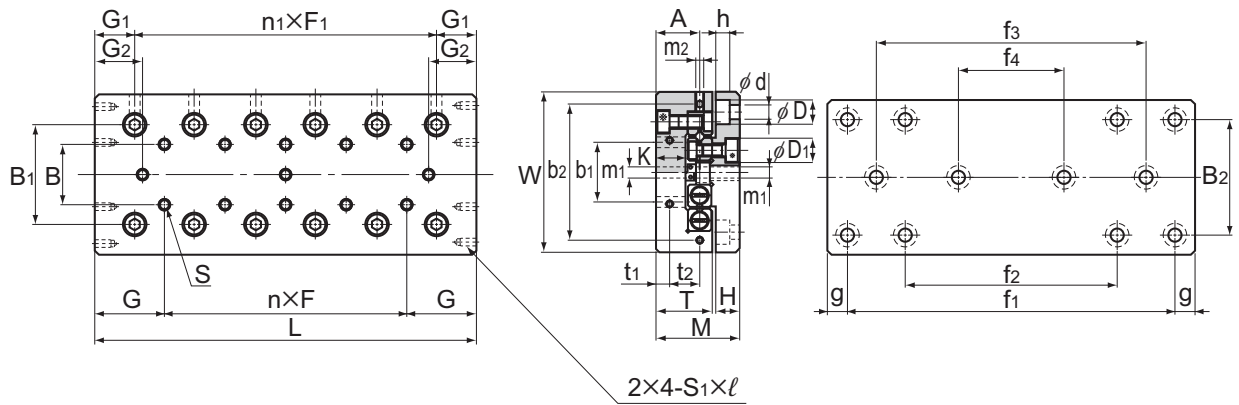

Model No.	Main dimensions					Table surface dimensions											
	Maximum stroke	Width W ±0.1	Height M ±0.1	Length L	Mass ^(Note) kg	Table mounting tap position				Side surface mounting tap position							
						B	n x F	G	S	B ₁	n ₁ x F ₁	G ₁	G ₂	b ₁	b ₂	t ₁	t ₂
VRU 6110	60	100	45	110	3.2(1.7)	—	—	—	—	—	1 x 50	16	60	92	8	15	M4 x 8
VRU 6160	95			160	4.6(2.5)	1 x 50	23.5										
VRU 6210	130			210	6(3.2)	2 x 50	31										
VRU 6260	165			260	7.4(4)	3 x 50	38.5										
VRU 6310	200			310	8.7(4.8)	4 x 50	46										
VRU 6360	235			360	10.1(5.6)	5 x 50	53.5										
VRU 6410	265			410	11.5(6.4)	6 x 50	63.5										
VRU 9210	130	145	60	210	12(7.1)	—	—	—	—	—	1 x 100	27	90	135	11	20	
VRU 9310	180			310	17.6(7.9)	1 x 100	52										
VRU 9410	350			410	23.2(—)	2 x 100	—										
VRU 9510	450			510	28.8(—)	3 x 100	—										
VRU 9610	550			610	34.4(—)	4 x 100	17										
VRU 9710	650			710	40(—)	5 x 100	—										
VRU 9810	750			810	45.6(—)	6 x 100	—										
* VRU 9910	850			910	51.2(—)	7 x 100	—										
* VRU 91010	950			1010	56.8(—)	8 x 100	—										

Note) Stainless steel type with high corrosion resistance is also available.
 The value in the parentheses represents the mass of a stainless steel type.
 Models VRU9910 and VRU91010 are build to order.

(Example) VRU 6310 M
 └ Symbol for stainless steel type
 (table base: aluminum)

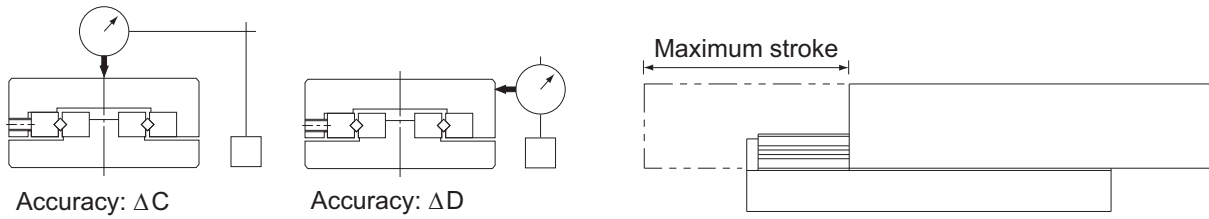
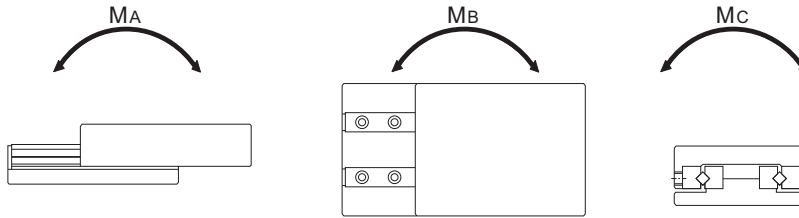

Unit: mm

Cross Roller Table

										Base surface dimensions Mounting hole position					Basic load rating		Static permissible moment			Accuracy μm	
T	H	K	d×D×h	D ₁	m ₁	A	m ₂	B ₂	f ₁	f ₂	f ₃	f ₄	g	No. of rollers Z	C kN	C ₀ kN	M _A N-m	M _B N-m	M _C N-m	ΔC	ΔD
31	13	15	7×11×7	11	M5	23.5	M5	60	90	—	—	—	10	6	16.4	22.7	150	172	510	3	6
									140	—	—	—		9	20.5	30.2	410	367	680	3	6
									190	—	90	—		13	28.2	45.3	800	740	1020	3	7
									240	—	140	—		16	35.3	60.5	1040	1100	1360	3	7
									290	—	190	—		19	38.8	68.0	1630	1540	1530	4	8
									340	140	240	—		22	45.3	83.1	1970	2050	1870	4	8
									390	190	290	—		26	51.6	98.3	2750	2840	2210	4	8
43	16	21	9×14×9	14	M8	32	M6	90	100	—	—	—	55	9	52.3	75.8	1440	1290	2730	3	7
									200	—	—	—		14	81.1	133	2810	2990	4780	3	7
									300	—	100	—		15	81.1	133	3660	3420	4780	4	8
									400	—	200	—		19	98.7	171	5710	5410	6140	4	8
									500	100	300	—		22	115	208	6910	7200	7500	4	9
									600	200	400	—		26	131	246	9640	9980	8870	4	9
									700	300	500	100		29	139	265	12800	12400	9550	5	10
									800	400	600	200		33	155	303	16500	15900	10900	5	10
									900	500	700	300		37	169	341	20500	20000	12300	5	10

Model Number Coding

Model number configurations differ depending on the model features. Refer to the corresponding sample model number configuration.

[Miniature type cross roller tables]

- Models VRT and VRT-A

VRT2035	M
└─	└─
Model No.	Symbol for stainless steel type

[Cross Roller Table]

- Model VRU

VRU2035	M
└─	└─
Model No.	Symbol for stainless steel type (table base: aluminum)

[Handling]

- (1) Disassembling components may cause dust to enter the system or degrade mounting accuracy of parts. Do not disassemble the product.
- (2) Dropping or hitting the Cross Roller Table may damage it. Giving an impact to it could also cause damage to its function even if the product looks intact.

[Lubrication]

- (1) For lubrication of the Cross Roller Table, use lithium-soap group grease or oil when it is necessary as with ordinary bearings.
- (2) Thoroughly remove anti-rust oil and feed lubricant before using the product.
- (3) Do not mix lubricants of different physical properties.
- (4) In locations exposed to constant vibrations or in special environments such as clean rooms, vacuum and low/high temperature, normal lubricants may not be used. Contact THK for details.
- (5) When planning to use a special lubricant, contact THK before using it.

[Offset of the Cage]

The cage, which retains rollers (or balls), demonstrates extremely accurate motion. However, it may be offset as affected by driving vibrations, inertia or impact.

If using the Cross Roller Guide or Ball Guide in the following conditions, contact THK.

- Vertical use
- Pneumatic cylinder drive
- Cam drive
- High speed crank drive
- Under a large moment load
- Butting the guide's external stopper with the table

[Precautions on Use]

- (1) Entrance of foreign material may cause damage to the ball circulating component or functional loss. Prevent foreign material, such as dust or cutting chips, from entering the system.
- (2) If foreign material adheres to the product, replenish the lubricant after cleaning the product.
- (3) Contact THK if you desire to use the product at a temperature of 100°C or higher.
- (4) When using the product in locations exposed to constant vibrations or in special environments such as clean rooms, vacuum and low/high temperature, contact THK in advance.

[Storage]

When storing the Cross Roller Table, enclose it in a package designated by THK and store it while avoiding high temperature, low temperature and high humidity.